



«We have to replace beauty, which is a cultural concept,  
with goodness, which is a humanist concept»

Gui Bonsiepe

## OPENTECH'S FILOSOFIE

OPENTECH is een internationaal vooraanstaande Italiaanse fabrikant van deurbeslag en accessoires. OPENTECH's missie is het creëren van duurzame, trendsettende innovaties – in termen van productie, functionaliteit, toepassing en uitstraling – door continue te blijven stimuleren en vergelijken en door te luisteren naar mensen die dezelfde waarden delen.

Resultaat van deze visie resulteert in het vermogen om een selectie technische modellen te leveren, met een unieke schoonheid, herkenbare sobere lijnen, verfijnde esthetiek, aandacht voor de gebruiker en voor de kwaliteit van grondstoffen en productieproces.

## AANDACHT VOOR HET MILIEU

Aandacht voor het milieu is een fundamenteel grondbeginsel bij OPENTECH, zowel als het gaat om productie en verpakking, als ook het industriële proces. Analyse en controle van het energieverbruik, het beperken van vervuiling tijdens de productie door het weglaten van vervuilende en giftige stoffen, recycling, Life Cycle Design, Life Cycle Analysis en gericht op milieuvriendelijkheid: al deze zaken zijn onderdeel van onze modus operandi.

## SOCIALE VERANTWOORDELIJKHEID

Een modern bedrijf is gebaseerd op respect voor de mens. Dat is waarom OPENTECH haar filosofie baseert op de rechten van de individuele rechten van de mens, om zo de meeste toegevoegde waarde te krijgen uit het human capital waar het bedrijf voor staat en die het bedrijf vertegenwoordigen.

De onderneming is ervan overtuigd dat het kan groeien wanneer het economisch efficiënt, sociaal in balans, ecologisch verantwoordelijk en innovatief van cultuur is. Alle lange termijn strategische beslissingen die het bedrijf raken worden genomen na evaluatie van de belangen van alle werknemers, klanten en leveranciers.

De onderneming gelooft hierin en streeft dit na door haar producten om te zetten in objecten die hun louter functionele aspect overtreffen. Zo worden de goederen niet alleen een gebruiksvoorwerp maar worden het objecten die de culturele en sociale waarden waarin we geloven overbrengen.

## WAAROM KIEZEN VOOR OPENTECH?



### PRODUCTIE

OPENTECH's complete bedrijfsvoering is gebaseerd op de volgende principes:

- volledig geproduceerd in Italië;
- conform Italiaanse arbeidswetgeving;
- conform strenge Italiaanse en Europese milieunormen;
- van grondstoffen en productiesystemen conform Europese regulering;
- belang in opzetten exclusieve partnerschappen met Europese leveranciers.



### PRODUCTEN

Alle OPENTECH producten kennen:

- een garantietermijn van 10 jaar (op het mechanisme);
- DIN EN 1906 klasse 3 of 4 certificering;
- innovatieve technische oplossingen;
- gepatenteerde technologie voor zowel product als design;
- OPENTECH logo voor onmiskenbare herkenbaarheid.



### GARANTIE

OPENTECH biedt garantie op mechanische functies van alle deur- en raambeslag, mits deze op de juiste wijze zijn gemonteerd en onderhouden. Alle OPENTECH producten ondergaan een serie van kwaliteitstesten om de statische en dynamische krachten te testen waaraan ze blootstaan tijdens hun gebruiksduur. De testcondities die toegepast worden in de laboratoria van OPENTECH zijn een stuk strenger dan deze van gelijksoortige tests die vereist zijn voor DIN EN 1906 normering.

HELP



### CUSTOMER SERVICE

Een efficiënte en innovatieve logistiek maakt het mogelijk voor OPENTECH om producten rechtstreeks uit voorraad te leveren, waarbij de klant profiteert door een lagere voorraad en distributiekosten.

## PRODUCTEIGENSCHAPPEN

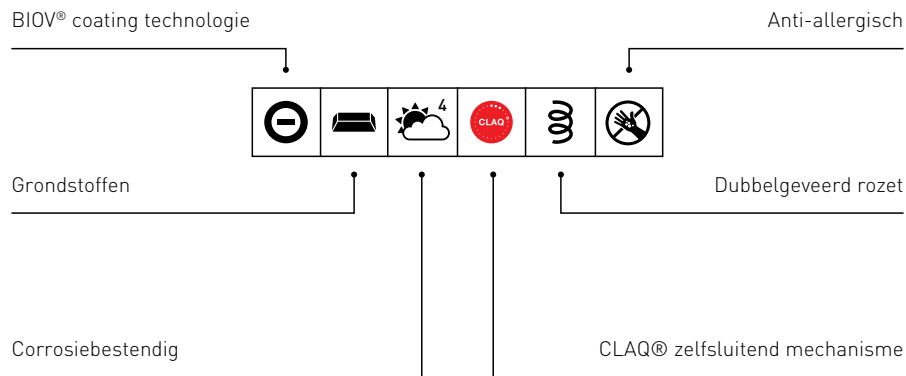

**BIOV®**

BIOV® is een oppervlakte-afwerking gebaseerd op de PVD (physical vapour deposition) techniek en vormt een laag rondom het product die bescherming biedt tegen corrosie en slijtage. Het is corrosiebestendig tegen weersinvloeden conform de DIN EN 1609 (EN1670) normering klasse 4 of 5, afhankelijk van het basismateriaal.

De beschikbare kleuren met BIOV® technologie zijn TECHNOSTEEL, CRYSTAL, NOIR, GOLD, ANTIQUE GOLD, WHITE PEARL en BLACK PEARL (zie pagina 28-29). Producten behandeld met BIOV® bevatten geen allergene elementen zoals chroom, kwik, nikkel of cadmium in de toplaag. Dit maakt ze bijzonder geschikt voor openbare ruimtes zoals ziekenhuizen, kinderdagverblijven en scholen.

De producten kunnen eenvoudig gereinigd worden met een zachte doek en een beetje azijn.



## GRONDSTOFFEN

Deurkrukken en accessoires worden vervaardigd van verschillende materialen en in verschillende productieprocessen, afhankelijk van de verlangde eisen en kenmerken. Alle producten worden in principe gemaakt van solide materialen. Wanneer een product hol is, is het symbool  afgebeeld.

De volgende grondstoffen worden gebruikt:

### AISI 316 EN RVS 304:

Dit zijn vormen van roestvast staal. De basis van beide materialen is een ijzer-carbon legering plus 18% nikkel en 8% chroom. AISI 316 RVS bevat daarnaast 2-3% molybdenum, wat de corrosiebestendigheid verhoogt bij aanraking met chlorides (bv. zeewater en strooizout). Alle AISI 316 RVS die door OPENTECH geproduceerd worden zijn verder afgewerkt met een BIOV coating, zodat ze gegarandeerd 20 jaar corrosiebestendig zijn.

RVS 304 RVS producten kennen 2 verschillende garantieperiodes. Niet behandelde producten hebben 2 jaar garantie, deze neemt toe naar 20 jaar bij behandeling met een BIOV coating. Om verwarring te voorkomen wordt deze laatste categorie aangeduid als AISI304+ (plus) producten. RVS producten behoeven geen speciaal onderhoud. Mocht er zogenaamde vliegroest optreden, dan zijn dit metaaldeeltjes uit de lucht die zich hechten aan het RVS en gaan oxideren. Dit komt niet uit het materiaal zelf. Vliegroest kan worden verwijderd door het materiaal goed te reinigen en onderhouden.

### MESSING:

Het messing dat gebruikt wordt voor het gieten voldoet aan de UNI EN 12165 CW617N norm.

### ZAMAK:

Dit is een familie van legeringen op zink-basis, met een toevoeging van aluminium, magnesium en koper. Het is vooral goed toepasbaar in druk-gieten door de uitstekende gietbaarheid en hardheid en vergelijkbaar met gietijzer en messing. De legering die OPENTECH gebruikt is ZAMAK 5, ook bekend als ZAMA 15 of UNI 3717 ZA4C legering.



## CORROSIEBESTENDIGHEID

De mate van corrosiebestendigheid, zowel natuurlijke als kunstmatige, wordt aangegeven middels de DIN EN 1609 (EN1670) norm. Hierbij worden zes klassen onderscheiden:

Klasse	Resistentie	Symbol	Grondstof / Finish	Garantie
<b>Klasse 0</b>	Niet geklassificeerd	-	-	-
<b>Klasse 1</b>	Licht	-	-	-
<b>Klasse 2</b>	Gemiddeld		AISI 304 / BRONZE	2 jaar
<b>Klasse 3</b>	Hoog		-	20 jaar
<b>Klasse 4</b>	Zeer hoog			20 jaar
<b>Klasse 5</b>	Extreem hoog		AISI 316 +	20 jaar

OPENTECH producten worden vervaardigd van verschillende materialen en hebben verschillende oppervlakte- afwerkingen. De combinatie van deze variabelen bepaalt de uiteindelijke resistentie van elk product.

Wanneer het symbol is afgebeeld bij de productomschrijving betekent dit, dat het product geschikt is om buiten toe te passen.

De klassen - zijn van toepassing op producten die gebruikt worden in een corrosiegevoelige omgeving, zoals aan de kust, of in een omgeving waar oplosmiddelen of sterke desinfecterende middelen gebruikt worden zoals waterstofperoxide (bv. ziekenhuizen).



## CLAQ® ZELFSLUITEND MECHANISME

CLAQ® is een nieuw bevestigingssysteem, zonder inbusschroef, voor een snelle montage van deurkrukken en raambomen. Het bevat een zelfsluitend mechanisme met een uniek remsysteem dat de krukstift exact in het midden positioneert.

Het CLAQ® systeem biedt de volgende voordelen:

- de deurkruk kan op eenvoudige manier degelijk gemonteerd worden, de montagetijd is 75% korter dan bij traditionele deurkrukken
- er is geen inbusschroef meer nodig voor het afmonteren van de kruk op de stift, waardoor er geen speling meer op de kruk kan ontstaan, ook kan de kruk niet meer zomaar loslaten.
- omdat er geen gebruik gemaakt wordt van inbusschroeven, hoeven de krukken na bevestiging niet meer nagesteld te worden, waardoor servicekosten gereduceerd worden. In de praktijk hoeft er dus niemand meer terug naar het project om de schroeven aan te draaien.
- het CLAQ® systeem is geklassificeerd conform de DIN EN 1906 norm en voldoet aan klasse 3 en 4, wat betekent dat het geschikt is voor deuren in gebouwen met een hoge gebruiksfrequentie, of in gebouwen waar sprake is van zware belasting (bv. openbare gebouwen zoals kazernes en stadions).
- de anti-inbraak en anti-demontage pin kan in het gatdeel aan de buitenzijde geplaatst worden
- het CLAQ® systeem heeft een garantie van 10 jaar op het mechanisme.

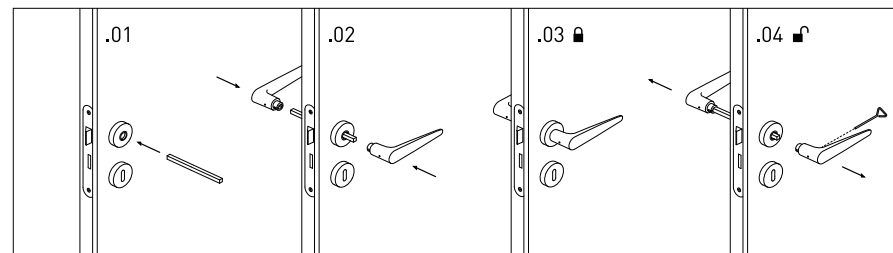

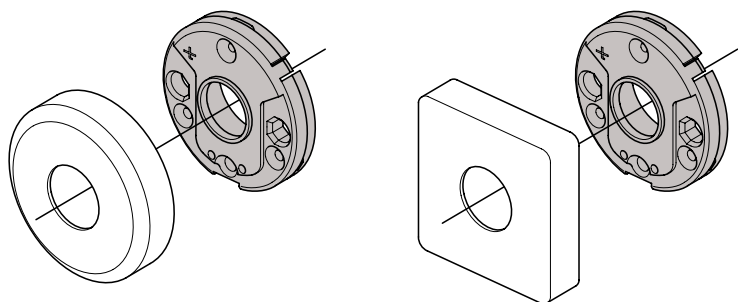

## DUBBELGEVEERD ROZET

Alle OPENTECH artikelen worden voorzien van een dubbel geveerd onderrozet, dat het mogelijk maakt de kruk tot 45° in twee richtingen te bewegen, tenzij anders gespecificeerd.

De belangrijkste kenmerken van de rozet zijn:

- 10 jaar mechanische garantie
- HOSTAFORM® (100% recyclebaar copolymeer) zelfsmarend en geluiddempend mechanisme
- kunnen door-en-door gemonteerd worden
- voorzien van RVS304 afdekkapje
- toepasbaar met nieuw CLAQ® zelfsluitend mechanisme voor ramen en deuren

Voordelen van de OPENTECH rozet:

- in 2 richtingen tot 45° te bewegen
- minder mechanische belasting van het slot
- kruk blijft in horizontale stand, ook na veelvuldig gebruik
- rozet is toepasbaar voor zowel links- als rechtswijzende krukken



## ANTI-ALLERGISCHE PRODUCTEN

Producten waarop dit symbool van toepassing is bevatten geen allergene elementen als chroom, kwik, nikkel of cadmium, die een allergische reactie kunnen veroorzaken. Dit maakt ze bijzonder geschikt om toe te passen in een omgeving waar mensen komen die hier gevoelig voor zijn, zoals ziekenhuizen, kinderopvangcentra en scholen.



## ANTIBACTERIEEL

Alle OPENTECH producten kunnen worden voorzien van een zilver zout coating die constant zilveren ionen afgeeft en hiermee bacteriën tot 99,9% reduceert. Dit is een blijvende eigenschap en behoeft geen specifiek onderhoud. De antibacteriele coating wordt aangeraden voor producten die worden toegepast in ruimtes waar een hoge mate van hygiëne is vereist, zoals ziekenhuizen, scholen en kinderopvangcentra. Deze optie moet bij bestelling van het artikel specifiek worden besteld.

## OPTIES

Dit betreft opties die in lijn zijn met specifieke Europese standaards (met name DIN EN 179) voor bouwkundige toepassingen.

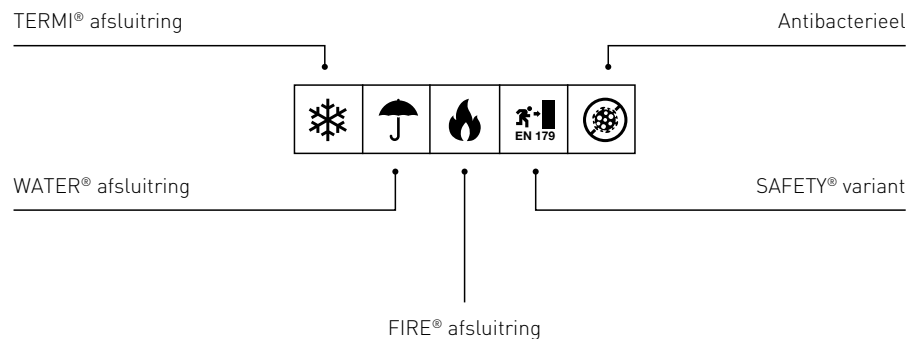

## GEBRUIKERSKLASSEN DIN EN 1906

DIN EN 1906 is een Europese standaard die vereisten en test methoden voorschrijft voor deurkrukken en knoppen (kijk op [www.OPENTECHitalia.com](http://www.OPENTECHitalia.com) voor meer details). Krukken ondergaan diverse testmethoden om de gebruikersklasse te bepalen. Er zijn vier klassen:

<b>Klasse 1</b>	Middelmatig frequent (intensief) gebruik door personen met een grote zorgvuldigheid waarbij slechts een kleine kans op onjuist gebruik aanwezig is. (bijv. binnendeuren in particuliere woningen).
<b>Klasse 2</b>	Middelmatig frequent (intensief) gebruik door personen met enige zorgvuldigheid waarbij enige kans op onjuist gebruik aanwezig is. (bijv. binnendeuren in kantoren).
<b>Klasse 3</b>	Hoogfrequent (zeer intensief) gebruik door publiek of andere personen met gering gevoel voor zorgvuldigheid waarbij een grote kans op onjuist gebruik bestaat. (bijv. deuren in publieke gebouwen).
<b>Klasse 4</b>	Hoogfrequent (zeer intensief) gebruik op deuren bij projecten waar regelmatig geweldsgebruik of zelfs over opzettelijk misbruik gesproken kan worden (bijv. voetbalstadions, kazernes of openbare toiletten).

De volgende tests worden gebruikt om de klasse van de kruk te bepalen:

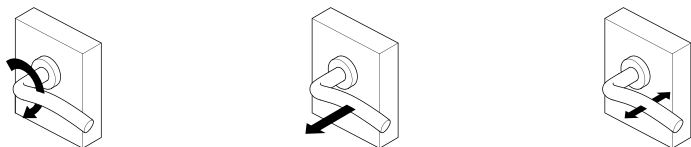

TORSIESTERKTE		TRACTIESTERKTE		HORIZONTALE SPELING	
20nm	klasse 1	300N	klasse 1	< 10mm	klasse 1
30nm	klasse 2	500N	klasse 2	< 10mm	klasse 2
40nm	klasse 3	800N	klasse 3	< 6mm	klasse 3
50nm	klasse 4	1000N	klasse 4	< 6mm	klasse 4



VERTICALE SPELING		DUURZAAMHEID	
< 10mm	klasse 1	10.000 test cycli	klasse 1-2
< 10mm	klasse 2	200.000 test cycli	klasse 3-4
< 5mm	klasse 3		
< 5mm	klasse 4		



Alle OPENTECH deur- en raambeslag voorzien van het CLAQ® bevestigingsmechanisme zijn klasse 3 of klasse 4 DIN EN 1906 gecertificeerd (klasse 4 op aanvraag).

Om deze reden wordt beslag met het CLAQ® mechanisme geadviseerd voor deuren met een zeer intensief gebruik en op plaatsen waar onjuist gebruik kan ontstaan.

## MECHANISCHE GARANTIE

OPENTECH geeft 10 jaar garantie op het mechanisch functioneren van alle raam- en deurbeslag, mits onze instructies voor montage en onderhoud zijn nageleefd. Deze garantietermijn ligt ver boven de minimumtermijn van 2 jaar die is vastgesteld door de Italiaanse Civiele Code.

Alle OPENTECH producten ondergaan een serie van kwaliteitstesten om een langdurig functioneren te garanderen.

### DEURKRUKKEN

Om de afgegeven garantietermijn te kunnen garanderen ondergaan OPENTECH deurkrukken een beduidend hoger aantal testbedieningen dan vereist onder DIN EN 1906. Alle deurkrukken ondergaan meer dan 500.000 cycli in het testlaboratorium van de fabriek en zijn met een klasse 7 op duurzaamheid gecertificeerd.

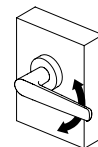

500.000 cycli = 140 cycli per dag gedurende 10 jaar

**N.B.** 1 cyclus = 1 opening + 1 sluiting

### RAAMBOMEN

OPENTECH raambomen zijn in het laboratorium getest op meer dan 15.000 bedieningen op een draai-kiep raam.

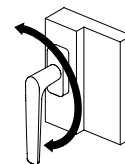

15.000 cycli = 4 cycli per dag gedurende 10 jaar

**N.B.** 1 cyclus = 1 opening + 1 sluiting + 1 draai-kiep beweging

# FINISHES

Finish naam en codering (AB=antibacterieel)

Antibacterieel (optioneel)

RVS 316+

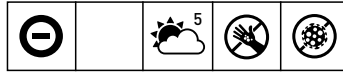

Finish

Type finish

Garantie op finish in jaren

Geschikt voor buiten

Anti-allergische producten



P.17

P.19

P.29

P.41

P.47

RVS 316+

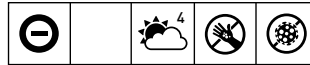

RVS 304

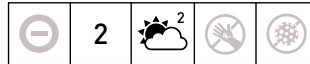

TECHNOSTEEL

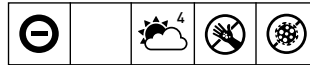

WHITE PEARL

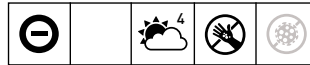

CRYSTAL

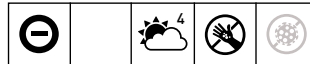

BLACK PEARL

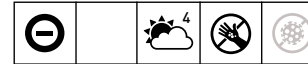

NOIR

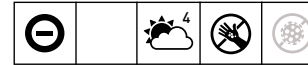

GOLD

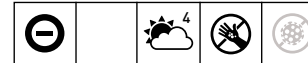

ANTIQUÉ GOLD

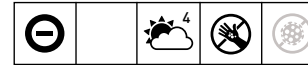

SATIN CHROME

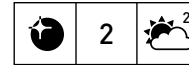

POLISH CHROME



DOUBLE CHROME

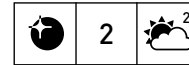

CILINDERSLOTEN

P.55

P.63

P.71

P.79

P.83

P.87

P.90

P.91



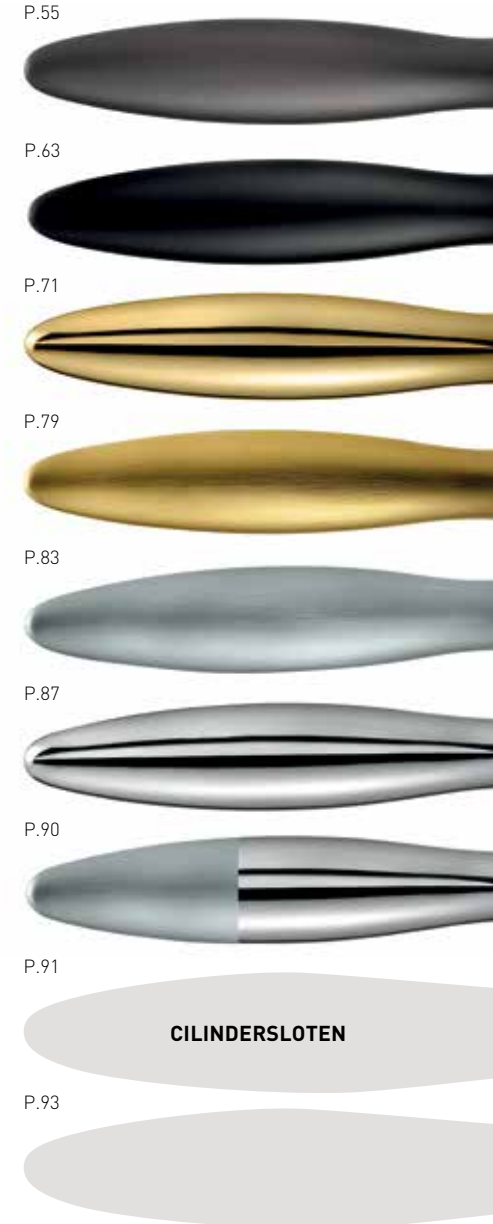







P.93



**CILINDERSLOTEN**





RVS 316+										
EN1906_KLASSE 4						OPTIES				
										



RIVA  
1250.2005.59



SALO  
1230.2005.59



TORRI  
1240.2005.59



FASANO  
1260.2005.59



CHORI  
1320.2006.59



CATULLO  
1270.2005.59

RVS 304										
EN1906_KLASSE 3						OPTIES				
										



RIVA  
1250.2005.19



SALO  
1230.2005.19



TORRI  
1240.2005.19



FASANO  
1260.2005.19



CHORI  
1320.2006.19



CATULLO  
1270.2005.19

RVS 304										
EN1906_KLASSE 3							OPTIES			













RVS 304 2MM PLATTE ROZETTEN										
EN1906_KLASSE 3							OPTIES			



88,00 <b>106,48</b>	17,50 <b>21,18</b>	17,50 <b>21,18</b>	39,00 <b>47,19</b>	66,04 <b>79,92</b>				OPTIE, PRIJS OP AANVRAAG		



RVS 304						
GREPEN						
				<b>2</b> JAAR	OPTIES	

RVS 304						
GREPEN						
				<b>2</b> JAAR	OPTIES	



TEKNO 45°  
0571.1012.19



TEKNO  
0571.1011.19



MODERN  
0571.1009.19



MODERN  
0571.1010.19

# RVS 304

TOEBEHOREN



2  
JAAR

OPTIES

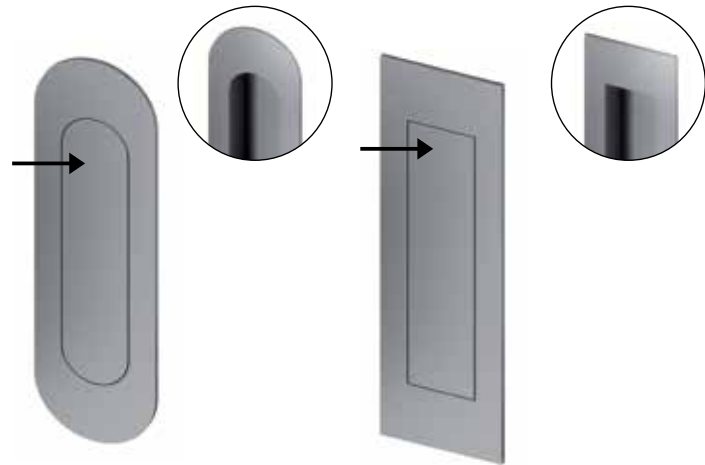

SDK OPAL  
6224.0088

SDK BRODY  
6225.0088



SDK BOBY  
6202.0088



SDK BRADLY  
6212.0088

# RVS 304

TOEBEHOREN



2  
JAAR

OPTIES



0341.0088

0229.00IX

VEILIGHEIDSRIZETTEN ROND

SDK SPECIAL  
S842.0088



7691.6388 [76 X 76 MM]  
8990.2388 [89 X 89 MM]  
8991.6388 RVS 201 [89 X 89 MM]



8995.2388

KOGELLAGER SCHARNIER

RVS 304									
TOEBEHOREN									
					OPTIES				



0692.9004.88



9650.0088



9649.0088

BRIEFPLATEN



VEILIGHEIDSET RVS  
KNOP/KRUK  
7874.0088 / 7879.0088



VEILIGHEIDSET RVS  
KRUK/KRUK  
7873.0088 / 7878.0088

RVS 304									
TOEBEHOREN									
					OPTIES				



BASIC EXC  
S913.0088



BASIC SYM  
S912.0088



0632.3003.19



0632.3004.19

VEILIGHEIDSRIZETTEN VIERKANT



DEURBEL  
S838.IX / S809.00IX



DEURBEL  
S911.0088



TECHNOSTEEL													
EN1906_KLASSE 3										OPTIES			



DODO  
1742.32N9



SOIANO  
2332.32N9



GEO  
1472.32N9



0  
1030.2001.03

TECHNOSTEEL													
EN1906_KLASSE 3										OPTIES			



RHINO  
0730.5001.03



RHINO 28MM VERKORT  
0735.0003.29

TECHNOSTEEL													
EN1906_KLASSE 3							OPTIES						



TECHNOSTEEL													
EN1906_KLASSE 3							OPTIES						





TECHNOSTEEL												
EN1906_KLASSE 3								OPTIES				

N.B. HOUTEN DEURBESLAG TOEGEPAST IN VOCHTIGE RUIMTES EN BUITEN ZAL IN DE LOOP DER TIJD VERGRUIZEN



ISABELLA / TIEL  
4720.32N9



VITTORIA / ROOSENDAAL  
4714.32N9

TECHNOSTEEL												
EN1906_KLASSE 3								OPTIES				







SCHUIFDEURKOMMEN  
0600.00N9







BLINDE ROZET  
0244.XXN9







BLIND SCHILD  
0008.AAN9 [PER STUK]

TECHNOSTEEL									
TOEBEHOREN									
								OPTIES	



TECHNOSTEEL									
TOEBEHOREN									
								OPTIES	



TECHNOSTEEL									
VEILIGHEIDSRIZETTEN									
								OPTIES	



0341.00N9



0632.3003.03

VEILIGHEIDSRIZETTEN ROND EN VIERKANT







0229.00N9



0632.3004.03

VEILIGHEIDSRIZETTEN ROND EN VIERKANT MET UTB

TECHNOSTEEL									
TOEBEHOREN									
								OPTIES	



DEURKLOPPER ANELLO  
0688.00N9



DEURBEL  
0601.00N9 / 6621.00N9



0692.9004.N9













0650.00N9



0649.00N9  
BRIEFPLATEN

WHITE PEARL



WHITE PEARL											
EN1906_KLASSE 3						OPTIES					
											







DODO  
1742.3266



SOIANO  
2332.3266



GEO  
1472.3266

WHITE PEARL										
TOEBEHOREN										OPTIES
										



SCHUIFDEURKOMMEN  
0600.0066



BLINDE ROZET  
0244.XX66



BLINDE SCHILDEN  
0008.AA66 (PER STUK)

WHITE PEARL										
EN1906_KLASSE 3					OPTIES					

WHITE PEARL										
VEILIGHEIDSRIZETTEN										
									OPTIES	



REMO  
1575.3266



DAPHNE  
2482.3266

0020.FR01



CLIO  
8563.3266







SVEZIA  
2498.0066



VEILIGHEIDSRIZETTEN ROND  
0341.0066



RONDE RIZETTEN MET UTB  
0229.0066

WHITE PEARL					
TOEBEHOREN					
					OPTIES 



DEURKLOPPER ANELLO  
0688.0066



DEURBEL  
0601.0066 / 6621.0066

46



0692.9004.66



0650.0066



0649.0066

BRIEFPLATEN



CLEANER  
CL0001

CRYSTAL

CRYSTAL										
EN1906_KLASSE 3					OPTIES					



DODO  
1742.3246



SOIANO  
2332.3246



GEO  
1472.3246

CRYSTAL										
EN1906_KLASSE 3					OPTIES					



GIOIA  
0750.2003.07



KOBÉ  
0740.2003.07



BOTTICELLI  
0150.2003.07



SOFIA  
1148.0103.56



GAIA  
0790.2001.07



CRYSTAL										
EN1906_KLASSE 3						OPTIES				



GAIUS  
0780.5001.07



CLOE  
1170.2001.07

CRYSTAL										
TOEBEHOREN										
									OPTIES	



SCHUIFDEURKOMMEN  
0600.0046



BLINDE ROZET  
0244.XX46



BLIND SCHILD  
0008.AA46 (PER STUK)

CRYSTAL										
EN1906_KLASSE 3					OPTIES					



REMO  
1575.3246



DAPHNE  
2482.3246

0020.FR01



CLIO  
8563.3246



SVEZIA  
2498.0046

CRYSTAL										
VEILIGHEIDSRIZETTEN										
									OPTIES	



0341.0046



0632.3003.07

VEILIGHEIDSRIZETTEN ROND EN VIERKANT







0229.0046



0632.3004.07

VEILIGHEIDSRIZETTEN ROND EN VIERKANT MET UTB

CRYSTAL									
TOEBEHOREN									
								OPTIES	



DEURKLOPPER ANELLO  
0688.0046



DEURBEL  
0601.0046 / 6621.0046

54



0692.9004.46



0650.0046



0649.0046

BRIEFPLATEN



CLEANER  
CL0001

BLACK PEARL

BLACK PEARL										
EN1906_KLASSE 3						OPTIES				



DODO  
1742.32T3



SOIANO  
2332.32T3



GEO  
1472.32T3

BLACK PEARL										
EN1906_KLASSE 3						OPTIES				



GIOIA  
0750.2003.04



KOBÉ  
0740.2003.04



SIRIUS  
0210.2003.04



BOTTICELLI  
0150.2003.04



GAIA  
0790.2001.04



SOFIA  
1148.0103.55

BLACK PEARL										
EN1906_KLASSE 3					OPTIES					



GAIUS  
0780.5001.04



CLOE  
1170.2001.04

BLACK PEARL									
TOEBEHOREN									OPTIES



SCHUIFDEURKOMMEN  
0600.00T3



BLINDE ROZET  
0244.XXT3



BLINDE SCHILDEN  
0008.AAT3 [PER STUK]

BLACK PEARL										
EN1906_KLASSE 3					OPTIES					



BLACK PEARL										
VEILIGHEIDSRIZETTEN										
									OPTIES	



VEILIGHEIDSRIZETTEN ROND EN VIERKANT



VEILIGHEIDSRIZETTEN ROND EN VIERKANT MET UTB

# BLACK PEARL

TOEBEHOREN

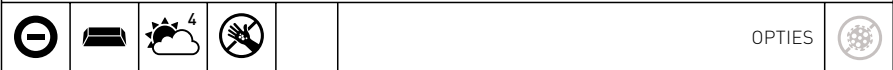

DEURKLOPPER ANELLO  
0688.00T3



DEURBEL  
0601.00T3 / 6621.00T3

62



0692.9004.T3



0650.00T3



0649.00T3

BRIEFPLATEN



CLEANER  
CL0001

NOIR

NOIR											
EN1906_KLASSE 3							OPTIES				



GEO  
1472.3208



SOIANO  
2332.3208



DODO  
1742.3208

NOIR											
EN1906_KLASSE 3							OPTIONS_OPTIES				













0  
1030.2001.08







SIRIUS  
1290.3208



NOIR										
EN1906_KLASSE 3					OPTIES					
										



RHINO  
0730.5001.08

NOIR									
TOEBEHOREN									OPTIES
									



SCHUIFDEURKOMMEN  
0600.0008



BLINDE ROZET  
0244.XX08



BLINDE SCHILDEN  
0008.AA08 (PER STUK)

NOIR										
EN1906_KLASSE 3					OPTIES					



NOIR										
VEILIGHEIDSRIZETTEN										
									OPTIES	



VEILIGHEIDSRIZETTEN ROND



VEILIGHEIDSRIZETTEN VIERKANT MET UTB

NOIR					
TOEBEHOREN					
					OPTIES 



DEURKLOPPER ANELLO  
0688.0008



DEURBEL  
0601.008 / 6621.0008



0692.9004.08



0650.0008



0649.0008

BRIEFPLATEN



CLEANER  
CL0001

GOLD



GOLD										
EN1906_KLASSE 3						OPTIES				



DODO  
1742.3220



SOIANO  
2332.3220



GEO  
1472.3220

GOLD										
EN1906_KLASSE 3						OPTIES				



GIOIA  
0750.2003.28



KOBE  
0740.2003.28



SIRIUS  
0210.2003.01



BOTTICELLI  
0150.2003.28



GAIA  
0790.2001.28



SOFIA  
1148.0103.28

GOLD										
EN1906_KLASSE 3						OPTIES				



GAIUS  
0780.5001.28



CLOE  
1170.2001.28

GOLD										
TOEBEHOREN										
									OPTIES	



SCHUIFDEURKOMMEN  
0600.0020



BLINDE ROZET  
0244.XX20



BLINDE SCHILDEN  
0008.AA20 (PER STUK)

GOLD										
EN1906_KLASSE 3					OPTIES					







GOLD										
VEILIGHEIDSRIZETTEN										
									OPTIES	



VEILIGHEIDSRIZETTEN ROND



VEILIGHEIDSRIZETTEN VIERKANT MET UTB

GOLD					
TOEBEHOREN					
					OPTIES 



DEURKLOPPER ANELLO  
0688.0020



DEURBEL  
0601.0020 / 6621.0020

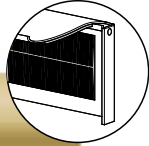

0692.9004.20



0650.0020



0649.0020

BRIEFPLATEN

ANTIQUE GOLD



ANTIQUE GOLD											
EN1906_KLASSE 3							OPTIES				



GEO  
1472.32P2

ANTIQUE GOLD											
EN1906_KLASSE 3							OPTIES				



CLIO  
8563.32P2







DAPHNE  
2482.32P2

0020.FR01



SVEZIA  
2498.00P2



ANTIQUE GOLD					
VEILIGHEIDSRUZETTEN EN TOEBEHOREN					
					OPTIES 



VEILIGHEIDSRUZETTEN ROND MET UTB  
0229.00P2



DEURBEL  
6621.00P2

82



0692.9004.P2

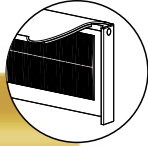

0650.00P2

BRIEFPLATEN



CLEANER  
CL0001

SATIN CHROME

SATIN CHROME										
EN1906_KLASSE 3							OPTIES			



GIOIA  
0750.2003.15



KOBE  
0740.2003.15



BOTTICELLI  
0150.2003.15



SOFIA  
1148.0103.15



GAIA  
0790.2001.15



BLIND SCHILD  
0008.AA12 (PER STUK)

SATIN CHROME										
EN1906_KLASSE 3							OPTIES			



GAIUS  
0780.5001.15



CLOE  
1170.2001.15



POLISH CHROME									
EN1906_KLASSE 3						OPTIES			



GIOIA  
0750.2003.14



KOBE  
0740.2003.14



BOTTICELLI  
0150.2003.14



GAIA  
0790.2001.14



BLIND SCHILD  
0008.AA07 (PER STUK)

POLISH CHROME									
EN1906_KLASSE 3									



GAIUS  
0780.5001.14



CLOE  
1170.2001.14

DOUBLE CHROME										
EN1906_KLASSE 3						OPTIES				



MERCURY  
1136.0010.30

65,00 <b>78,65</b>	16,50 <b>19,97</b>	16,50 <b>19,97</b>	34,84 <b>42,16</b>	43,80 <b>53,00</b>			OPTIE, PRIJS OP AANVRAAG		



MERCURY  
1136.0020.30

CILINDERSLOTEN



## CILINDERS



Cilinder 30-30  
0002.5050.01

Cilinder 30-45  
0002.3045.01

Cilinder 30-10  
0002.3010.01

## CILINDERS SKG\*\*



SKG Cilinder 30-30  
0001.5050.01

SKG Cilinder 30-45  
0001.3045.01

SKG Cilinder 30-10  
0001.3010.01

PRIJSLIJST

# Inhoud

<b>BINNENDEURBESLAG</b> .....	<b>96</b>
BOTTICELLI.....	96
CATULLO.....	96
CATULLO klasse 4 BIOV.....	96
CHORI.....	97
CHORI klasse 4 BIOV.....	97
CLIO.....	97
CLOE.....	98
DODO.....	98
FASANO.....	99
FASANO klasse 4 BIOV.....	99
GAIA.....	99
GAIUS.....	100
GEO.....	100
GEO LANGSCHILD.....	101
GIOIA.....	101
KOBE.....	102
MERCURY.....	102
"O".....	103
REMO.....	103
RHINO.....	103
RIVA.....	104
RIVA klasse 4 BIOV.....	104
ROOSENDAAL.....	104
SALO.....	105
SALO klasse 4 BIOV.....	105
SALO Flat rond.....	105
SALO Flat vierkant.....	106
SIRIUS.....	106
SOFIA.....	107
SOIANO.....	107
TIEL.....	108
TORRI.....	108
TORRI klasse 4 BIOV.....	108
<b>DIVERSE BINNEN</b> .....	<b>110</b>
ROZETTEN ROND (per set).....	110
TOILETGARNITUREN ROND.....	111
ROZETTEN VIERKANT (per set).....	112
TOILETGARNITUREN VIERKANT.....	113
LANGSCHILDEN VOOR HOUT EN KUNSTSTOF.....	113
RAAMBESLAG t.b.v. draai-kiep.....	114
SCHUIFDEURKOMMEN.....	115
SCHARNIEREN.....	116

<b>BUITENDEURBESLAG</b> .....	<b>117</b>
VOORDEURKNOPPEN.....	117
VOORDEURGREPEN.....	118
DEURKLOPPERS.....	118
VEILIGHEIDSRUZETTEN & VEILIGHEIDSSCHILDEN.....	119
BELDRUKKERS.....	120
BRIEFPLATEN & TOCHTKLEPPEN.....	121
<b>DIVERSE KLEINMATERIALEN</b> .....	<b>121</b>

## BINNENDEURBESLAG

### BOTTICELLI



52mm rozet ROND- afmeting kruk 71x119mm

EN 1906 KLASSE 3

KLEUR/FINISH	KRUKSTEL	SLEUTELROZET	CILINDERROZET	WC GARNITUUR	GATDEEL L/R
GOLD	0150.2003.28	0370.0020	0371.0020	0678.3220	0150.2003.28 LR
TECHNOSTEEL	0150.2003.29	0370.00N9	0371.00N9	0678.32N9	0150.2003.29 LR
BLACK PEARL	0150.2003.04	0370.00T3	0371.00T3	0678.32T3	0150.2003.04 LR
CRYSTAL	0150.2003.07	0370.0046	0371.0046	0678.3246	0150.2003.07 LR



52mm rozet ROND- afmeting kruk 71x119mm

EN 1906 KLASSE 3

KLEUR/FINISH	KRUKSTEL	SLEUTELROZET	CILINDERROZET	WC GARNITUUR	GATDEEL L/R
CHROOM	0150.2003.14	0191.0007	0192.0007	0653.3207	0150.2003.14 LR
MAT CHROOM	0150.2003.15	0191.0012	0192.0012	0653.3212	0150.2003.15 LR

### CATULLO



52mm rozet ROND - afmeting kruk 60x125mm

EN 1906 KLASSE 3

KLEUR/FINISH	KRUKSTEL	SLEUTELROZET	CILINDERROZET	WC GARNITUUR	GATDEEL L	GATDEEL R
RVS 304	1270.2005.19	0652.5002.19	0652.5001.19	0511.2001.19	1270.2005.19LI	1270.2005.19RE

### CATULLO klasse 4 BIOV



52mm rozet ROND - afmeting kruk 60x125mm

EN 1906 KLASSE 4

KLEUR/FINISH	KRUKSTEL	SLEUTELROZET	CILINDERROZET	WC GARNITUUR	GATDEEL L	GATDEEL R
RVS 316/304+_V2A+BIOV	1270.2005.59	0652.5002.59	0652.5001.59	0511.2001.59	1270.2005.59LI	1270.2005.59RE

### CHORI



52mm rozet ROND - afmeting kruk 60x125mm

EN 1906 KLASSE 3

KLEUR/FINISH	KRUKSTEL	SLEUTELROZET	CILINDERROZET	WC GARNITUUR	GATDEEL L	GATDEEL R
RVS 304	1320.2006.19	0652.5002.19	0652.5001.19	0511.2001.19	1320.2006.19LI	1320.2006.19RE

### CHORI klasse 4 BIOV



52mm rozet ROND - afmeting kruk 60x125mm

EN 1906 KLASSE 4

KLEUR/FINISH	KRUKSTEL	SLEUTELROZET	CILINDERROZET	WC GARNITUUR	GATDEEL L	GATDEEL R
RVS 316/304+ BIOV	1320.2006.59	0652.5002.59	0652.5001.59	0511.2001.59	1320.2006.59LI	1320.2006.59RE

### CLIO



52mm rozet ROND - afmeting kruk 62x87mm

EN 1906 KLASSE 3

KLEUR/FINISH	KRUKSTEL	SLEUTELROZET	CILINDERROZET	WC GARNITUUR	GATDEEL LI	GATDEEL RE
GOLD BIOV	8563.3220	0370.0020	0371.0020	0678.3220	8565.3220	8564.3220
GOLD ANTIQUE BIOV	8563.32P2	0370.00P2	0371.00P2	0678.32P2	8565.32P2	8564.32P2
TECHNOSTEEL BIOV	8563.32N9	0370.00N9	0371.00N9	0678.32N9	8565.32N9	8564.32N9

BLACK PEARL BIOV	8563.32T3	0370.00T3	0371.00T3	0678.32T3	8565.32T3	8564.32T3
CRYSTAL BIOV	8563.3246	0370.0046	0371.0046	0678.3246	8565.3246	8564.3246
WHITE PEARL BIOV	8563.3266	0370.0066	0371.0066	0678.3266	8565.3266	8564.3266
NOIR BIOV	8563.3208	0370.0008	0371.0008	0678.3208	8565.3208	8564.3208



## CLOE



	52mm rozet VIERKANT - afmeting kruk 61x125mm																		
--	--	--	--	--	--	--	--	--	--	--	--	--	--	--	--	--	--	--	--

EN 1906 KLASSE 3																			
KLEUR/FINISH		KRUKSTEL	SLEUTELROZET	CILINDERROZET	WC GARNITUUR	GATDEEL L/R													
GOLD		1170.2001.28	0652.5004.01	0652.5003.01	0511.2002.01	1170.2001.28LR													
TECHNOSTEEL		1170.2001.29	0652.5004.03	0652.5003.03	0511.2002.03	1170.2001.29LR													
BLACK PEARL		1170.2001.04	0652.5004.04	0652.5003.04	0511.2002.04	1170.2001.04LR													
CRYSTAL		1170.2001.07	0652.5004.07	0652.5003.07	0511.2002.07	1170.2001.07LR													

	52mm rozet VIERKANT - afmeting kruk 61x125mm																		
--	--	--	--	--	--	--	--	--	--	--	--	--	--	--	--	--	--	--	--

EN 1906 KLASSE 3																			
KLEUR/FINISH		KRUKSTEL	SLEUTELROZET	CILINDERROZET	WC GARNITUUR	GATDEEL L/R													
CHROOM		1170.2001.14	0181.0007	0182.0007	0651.3207	1170.2001.14LR													
MAT CHROOM		1170.2001.15	0181.0012	0182.0012	0651.3212	1170.2001.15LR													

## DODO



	52mm rozet ROND - afmeting kruk 55x112mm																		
--	--	--	--	--	--	--	--	--	--	--	--	--	--	--	--	--	--	--	--

EN 1906 KLASSE 3																			
KLEUR/FINISH		KRUKSTEL	SLEUTELROZET	CILINDERROZET	WC GARNITUUR	GATDEEL L/R													
GOLD BIOV		1742.3220	0370.0020	0371.0020	0678.3220	1742.3220LR													
TECHNOSTEEL BIOV		1742.32N9	0370.00N9	0371.00N9	0678.32N9	1742.32N9LR													
BLACK PEARL BIOV		1742.32T3	0370.00T3	0371.00T3	0678.32T3	1742.32T3LR													
CRYSTAL BIOV		1742.3246	0370.0046	0371.0046	0678.3246	1742.3246LR													
WHITE PEARL BIOV		1742.3266	0370.0066	0371.0066	0678.3266	1742.3266LR													
NOIR BIOV		1742.3208	0370.0008	0371.0008	0678.3208	1742.3208LR													

## FASANO



	52mm rozet ROND - afmeting kruk 60x116mm																		
--	--	--	--	--	--	--	--	--	--	--	--	--	--	--	--	--	--	--	--

EN 1906 KLASSE 3																			
KLEUR/FINISH		KRUKSTEL	SLEUTELROZET	CILINDERROZET	WC GARNITUUR	GATDEEL LI		GATDEEL RE											
RVS 304		1260.2005.19	0652.5002.19	0652.5001.19	0511.2001.19	1260.2005.19LI		1260.2005.19RE											

## FASANO klasse 4 BIOV



	52mm rozet ROND - afmeting kruk 60x116mm																		
--	--	--	--	--	--	--	--	--	--	--	--	--	--	--	--	--	--	--	--

EN 1906 KLASSE 4																			
KLEUR/FINISH		KRUKSTEL	SLEUTELROZET	CILINDERROZET	WC GARNITUUR	GATDEEL LI		GATDEEL RE											
RVS 316/304+ BIOV		1260.2005.59	0652.5002.59	0652.5001.59	0511.2001.59	1260.2005.59LI		1260.2005.59RE											

## GAIA



	52mm rozet ROND - afmeting kruk 48x128mm																		
--	--	--	--	--	--	--	--	--	--	--	--	--	--	--	--	--	--	--	--

EN 1906 KLASSE 3																			
KLEUR/FINISH		KRUKSTEL	SLEUTELROZET	CILINDERROZET	WC GARNITUUR	GATDEEL L/R													
GOLD		0790.2001.28	0370.0020	0371.0020	0678.3220	0790.2001.28LR													
TECHNOSTEEL		0790.2001.29	0370.00N9	0371.00N9	0678.32N9	0790.2001.29LR													
BLACK PEARL		0790.2001.04	0370.00T3	0371.00T3	0678.32T3	0790.2001.04LR													
CRYSTAL		0790.2001.07	0370.0046	0371.0046	0678.3246	0790.2001.07LR													

	52mm rozet ROND - afmeting kruk 48x128mm																		
--	--	--	--	--	--	--	--	--	--	--	--	--	--	--	--	--	--	--	--

EN 1906 KLASSE 3																			
KLEUR/FINISH		KRUKSTEL	SLEUTELROZET	CILINDERROZET	WC GARNITUUR	GATDEEL L/R													
CHROOM		0790.2001.14	0191.0007	0192.0007	0653.3207	0790.2001.14LR													
MAT CHROOM		0790.2001.15	0191.0012	0192.0012	0653.3212	0790.2001.15LR													

**GAIUS**

	52mm rozet VIERKANT- afmeting kruk 48x128mm																
--	---	--	--	--	--	--	--	--	--	--	--	--	--	--	--	--	--

EN 1906 KLASSE 3																	
<b>KLEUR/FINISH</b>		<b>KRUKSTEL</b>	<b>SLEUTELROZET</b>	<b>CILINDERROZET</b>	<b>WC GARNITUUR</b>	<b>GATDEEL L/R</b>											
GOLD		0780.5001.28	0652.5004.01	0652.5003.01	0511.2002.01	0780.5001.28LR											
TECHNOSTEEL		0780.5001.29	0652.5004.03	0652.5003.03	0511.2002.03	0780.5001.29LR											
BLACK PEARL		0780.5001.04	0652.5004.04	0652.5003.04	0511.2002.04	0780.5001.04LR											
CRYSTAL		0780.5001.07	0652.5004.07	0652.5003.07	0511.2002.07	0780.5001.07LR											

	52mm rozet VIERKANT - afmeting kruk 48x128mm																
--	--	--	--	--	--	--	--	--	--	--	--	--	--	--	--	--	--

EN 1906 KLASSE 3																	
<b>KLEUR/FINISH</b>		<b>KRUKSTEL</b>	<b>SLEUTELROZET</b>	<b>CILINDERROZET</b>	<b>WC GARNITUUR</b>	<b>GATDEEL L/R</b>											
CHROOM		0780.5001.14	0181.0007	0182.0007	0651.3207	0780.5001.14LR											
MAT CHROOM		0780.5001.15	0181.0012	0182.0012	0651.3212	0780.5001.15LR											

**GIOIA**

	52mm rozet ROND- afmeting kruk 59x125mm																
--	---	--	--	--	--	--	--	--	--	--	--	--	--	--	--	--	--

EN 1906 KLASSE 3																	
<b>KLEUR/FINISH</b>		<b>KRUKSTEL</b>	<b>SLEUTELROZET</b>	<b>CILINDERROZET</b>	<b>WC GARNITUUR</b>	<b>GATDEEL L/R</b>											
GOLD		0750.2003.28	0370.0020	0371.0020	0678.3220	0750.2003.28LR											
TECHNOSTEEL		0750.2003.29	0370.00N9	0371.00N9	0678.32N9	0750.2003.29LR											
BLACK PEARL		0750.2003.04	0370.00T3	0371.00T3	0678.32T3	0750.2003.04LR											
CRYSTAL		0750.2003.07	0370.0046	0371.0046	0678.3246	0750.2003.07LR											

	52mm rozet ROND- afmeting kruk 59x125mm																
--	---	--	--	--	--	--	--	--	--	--	--	--	--	--	--	--	--

EN 1906 KLASSE 3																	
<b>KLEUR/FINISH</b>		<b>KRUKSTEL</b>	<b>SLEUTELROZET</b>	<b>CILINDERROZET</b>	<b>WC GARNITUUR</b>	<b>GATDEEL L/R</b>											
CHROOM		0750.2003.14	0191.0007	0192.0007	0653.3207	0750.2003.14LR											
MAT CHROOM		0750.2003.15	0191.0012	0192.0012	0653.3212	0750.2003.15LR											

**GEO**



	52mm rozet ROND - afmeting kruk 55x115mm																
--	--	--	--	--	--	--	--	--	--	--	--	--	--	--	--	--	--

EN 1906 KLASSE 3																	
<b>KLEUR/FINISH</b>		<b>KRUKSTEL</b>	<b>SLEUTELROZET</b>	<b>CILINDERROZET</b>	<b>WC GARNITUUR</b>	<b>GATDEEL L/R</b>											
GOLD BIOV		1472.3220	0370.0020	0371.0020	0678.3220	1472.3220LR											
GOLD ANTIQUE BIOV		1472.32P2	0370.00P2	0371.00P2	0678.32P2	1472.32P2LR											
TECHNOSTEEL BIOV		1472.32N9	0370.00N9	0371.00N9	0678.32N9	1472.32N9LR											
BLACK PEARL BIOV		1472.32T3	0370.00T3	0371.00T3	0678.32T3	1472.32T3LR											
CRYSTAL BIOV		1472.3246	0370.0046	0371.0046	0678.3246	1472.3246LR											
WHITE PEARL BIOV		1472.3266	0370.0066	0371.0066	0678.3266	1472.3266LR											
NOIR BIOV		1472.3208	0370.0008	0371.0008	0678.3208	1472.3208LR											

**KOBE**



		52mm rozet ROND - afmeting kruk 58x114mm					
EN 1906 KLASSE 3							
KLEUR/FINISH	KRUKSTEL	SLEUTELROZET	CILINDERROZET	WC GARNITUUR	GATDEEL L/R		
GOLD	0740.2003.28	0370.0020	0371.0020	0678.3220	0740.2003.28LR		
TECHNOSTEEL	0740.2003.29	0370.00N9	0371.00N9	0678.32N9	0740.2003.29LR		
BLACK PEARL	0740.2003.04	0370.00T3	0371.00T3	0678.32T3	0740.2003.04LR		
CRYSTAL	0740.2003.07	0370.0046	0371.0046	0678.3246	0740.2003.07LR		

		52mm rozet ROND- afmeting kruk 58x114mm					
EN 1906 KLASSE 3							
KLEUR/FINISH	KRUKSTEL	SLEUTELROZET	CILINDERROZET	WC GARNITUUR	GATDEEL L/R		
CHROOM	0740.2003.14	0191.0007	0192.0007	0653.3207	0740.2003.14LR		
MAT CHROOM	0740.2003.15	0191.0012	0192.0012	0653.3212	0740.2003.15LR		

**MERCURY**



		52mm rozet ROND - afmeting kruk 65x113mm					
EN 1906 KLASSE 3							
KLEUR/FINISH	KRUKSTEL	SLEUTELROZET	CILINDERROZET	WC GARNITUUR	GATDEEL LI	GATDEEL RE	
MAT CHROOM/CHR.	1136.0010.30	0191.0012	0192.0012	0653.3212	1136.0010.30L	1136.0010.30R	



		52mm rozet VIERKANT - afmeting kruk 65x113mm					
EN 1906 KLASSE 3							
KLEUR/FINISH	KRUKSTEL	SLEUTELROZET	CILINDERROZET	WC GARNITUUR	GATDEEL LI	GATDEEL RE	
MAT CHROOM/CHR.	1136.0020.30	0181.0012	0182.0012	0651.0012	1136.0020.30L	1136.0020.30R	

**"O"**



		52mm rozet ROND- afmeting krukstel 49x128mm					
EN 1906 KLASSE 3							
KLEUR/FINISH	KRUKSTEL	SLEUTELROZET	CILINDERROZET	WC GARNITUUR	GATDEEL L/R		
TECHNOSTEEL BIOV	1030.2001.03	0370.00N9	0371.00N9	0678.32N9	1030.2001.03LR		
NOIR BIOV	1030.2001.08	0370.0008	0371.0008	0678.3208	1030.2001.08LR		

**REMO**



		52mm rozet ROND - afmeting kruk 59x62mm					
EN 1906 KLASSE 3							
KLEUR/FINISH	KRUKSTEL	SLEUTELROZET	CILINDERROZET	WC GARNITUUR	GATDEEL L/R		
GOLD BIOV	1575.3220	0370.0020	0371.0020	0678.3220	1575.3220LR		
TECHNOSTEEL BIOV	1575.32N9	0370.00N9	0371.00N9	0678.32N9	1575.32N9LR		
BLACK PEARL BIOV	1575.32T3	0370.00T3	0371.00T3	0678.32T3	1575.32T3LR		
CRYSTAL BIOV	1575.3246	0370.0046	0371.0046	0678.3246	1575.3246LR		
WHITE PEARL BIOV	1575.3266	0370.0066	0371.0066	0678.3266	1575.3266LR		
NOIR BIOV	1575.3208	0370.0008	0371.0008	0678.3208	1575.3208LR		

**RHINO**



		52mm rozet VIERKANT - afmeting kruk 61x125mm					
EN 1906 KLASSE 3							
KLEUR/FINISH	KRUKSTEL	SLEUTELROZET	CILINDERROZET	WC GARNITUUR	GATDEEL L/R	VERKORT 28MM	
TECHNOSTEEL BIOV	0730.5001.03	0652.5004.03	0652.5003.03	0511.2002.03	0730.5001.03LR	0735.0003.29	
NOIR BIOV	0730.5001.08	0652.5004.08	0652.5003.08	0511.2002.08	0730.5001.08LR		

## RIVA



52mm rozet ROND- afmeting kruk 60x118mm

EN 1906 KLASSE 3

KLEUR/FINISH	KRUKSTEL	SLEUTELROZET	CILINDERROZET	WC GARNITUUR	GATDEEL L/R
RVS 304	1250.2005.19	0652.5002.19	0652.5001.19	0511.2001.19	1250.2005.19LR

## SALO



52mm rozet ROND- afmeting kruk 60x115mm

EN 1906 KLASSE 3

KLEUR/FINISH	KRUKSTEL	SLEUTELROZET	CILINDERROZET	WC GARNITUUR	GATDEEL L/R
RVS 304	1230.2005.19	0652.5002.19	0652.5001.19	0511.2001.19	1230.2005.19LR



52mm rozet VIERKANT- afmeting kruk 60x115mm

EN 1906 KLASSE 3

KLEUR/FINISH	KRUKSTEL	SLEUTELROZET	CILINDERROZET	WC GARNITUUR	GATDEEL L/R
RVS 304	1230.5001.19	0652.5004.19	0652.5003.19	0511.2002.19	1230.5001.19LR

## RIVA klasse 4 BIOV



52mm rozet ROND - afmeting kruk 60x118mm

EN 1906 KLASSE 4

KLEUR/FINISH	KRUKSTEL	SLEUTELROZET	CILINDERROZET	WC GARNITUUR	GATDEEL L/R
RVS 316/304+ BIOV	1250.2005.59	0652.5002.59	0652.5001.59	0511.2001.59	1250.2005.59LR

## SALO klasse 4 BIOV



52mm rozet ROND- afmeting kruk 60x115mm

EN 1906 KLASSE 4

KLEUR/FINISH	KRUKSTEL	SLEUTELROZET	CILINDERROZET	WC GARNITUUR	GATDEEL L/R
RVS 316/304+ BIOV	1230.2005.59	0652.5002.59	0652.5001.59	0511.2001.59	1230.2005.59LR

## ROSENDAAL (VITTORIA)



52mm rozet ROND - afmeting kruk 55x115mm  
ebbenhout is buiten toepasbaar; dit zal in de loop der tijd vergrijzen

EN 1906 KLASSE 3

KLEUR/FINISH	KRUKSTEL	SLEUTELROZET	CILINDERROZET	WC GARNITUUR	GATDEEL LI	GATDEEL RE
TECHNOSTEEL BIOV	4714.32N9	0370.00N9	0371.00N9	0678.32N9	4714.32N9LI	4714.32N9RE

## SALO Flat rose rond



52mm rozet ROND FLAT : 2mm dik - afmeting kruk 60x115mm

EN 1906 KLASSE 3

KLEUR/FINISH	KRUKSTEL	SLEUTELROZET	CILINDERROZET	WC GARNITUUR	GATDEEL L/R
RVS 304_V2A	5101.3288	2031.0311	2031.0321	2031.0331	5101.3288LR

## SALO Flat rose vierkant



52mm rozet VIERKANT FLAT : 2mm dik - afmeting kruk 60x115mm

EN 1906 KLASSE 3

KLEUR/FINISH	KRUKSTEL	SLEUTELROZET	CILINDERROZET	WC GARNITUUR	GATDEEL L/R
RVS 304_V2A	5113.3288	2030.03C1	2030.0321	2030.0331	5113.3288LR

## SIRIUS



52mm rozet ROND - afmeting kruk 57x119mm

EN 1906 KLASSE 3

KLEUR/FINISH	KRUKSTEL	SLEUTELROZET	CILINDERROZET	WC GARNITUUR	GATDEEL L/R
GOLD	0210.2003.01	0370.0020	0371.0020	0678.3220	0210.2003.01LR
TECHNOSTEEL	0210.2003.03	0370.00N9	0371.00N9	0678.32N9	0210.2003.03LR
BLACK PEARL	0210.2003.04	0370.00T3	0371.00T3	0678.32T3	0210.2003.04LR

## SIRIUS



52mm rozet ROND - afmeting kruk 57x119mm

EN 1906 KLASSE 3

KLEUR/FINISH	KRUKSTEL	SLEUTELROZET	CILINDERROZET	WC GARNITUUR	GATDEEL L/R
NOIR BIOV	1290.3208	0370.0008	0371.0008	0678.3208	1290.3208LR

## SOFIA



52mm rozet ROND - afmeting kruk 48x128mm

EN 1906 KLASSE 3

KLEUR/FINISH	KRUKSTEL	SLEUTELROZET	CILINDERROZET	WC GARNITUUR	GATDEEL L/R
GOLD	1148.0103.28	0370.0020	0371.0020	0678.3220	1148.0103.28LR
TECHNOSTEEL	1148.0103.29	0370.00N9	0371.00N9	0678.32N9	1148.0103.29LR
BLACK PEARL	1148.0103.55	0370.00T3	0371.00T3	0678.32T3	1148.0103.55LR
CRYSTAL	1148.0103.56	0370.0046	0371.0046	0678.3246	1148.0103.56LR



52mm rozet ROND - afmeting kruk 48x128mm

EN 1906 KLASSE 3

KLEUR/FINISH	KRUKSTEL	SLEUTELROZET	CILINDERROZET	WC GARNITUUR	GATDEEL L/R
MAT CHROOM	1148.0103.15	0191.0012	0192.0012	0653.3212	1148.0103.15LR

## SOIANO



52mm rozet ROND - afmeting kruk 55x123mm

EN 1906 KLASSE 3

KLEUR/FINISH	KRUKSTEL	SLEUTELROZET	CILINDERROZET	WC GARNITUUR	GATDEEL LI	GATDEEL RE
GOLD BIOV	2332.3220	0370.0020	0371.0020	0678.3220	2332.3220LI	2332.3220RE
TECHNOSTEEL BIOV	2332.32N9	0370.00N9	0371.00N9	0678.32N9	2332.32N9LI	2332.32N9RE
BLACK PEARL BIOV	2332.32T3	0370.00T3	0371.00T3	0678.32T3	2332.32T3LI	2332.32T3RE
CRYSTAL BIOV	2332.3246	0370.0046	0371.0046	0678.3246	2332.3246LI	2332.3246RE
WHITE PEARL BIOV	2332.3266	0370.0066	0371.0066	0678.3266	2332.3266LI	2332.3266RE
NOIR BIOV	2332.3208	0370.0008	0371.0008	0678.3208	2332.3208LI	2332.3208RE

**TIEL (ISABELLA)**

					52mm rozet ROND- afmeting kruk 55x110mm ebbenhout is buiten toepasbaar; dit zal in de loop der tijd vergrijzen								
--	--	--	--	--	---	--	--	--	--	--	--	--	--

EN 1906 KLASSE 3

KLEUR/FINISH	KRUKSTEL	SLEUTELROZET	CILINDERROZET	WC GARNITUUR	GATDEEL LI	GATDEEL RE
TECHNOSTEEL BIOV	4720.32N9	0370.00N9	0371.00N9	0678.32N9	4720.32N9LI	4720.32N9RE

**TORRI**

					52mm rozet ROND- afmeting kruk 60x118mm								
--	--	--	--	--	---	--	--	--	--	--	--	--	--

EN 1906 KLASSE 3

KLEUR/FINISH	KRUKSTEL	SLEUTELROZET	CILINDERROZET	WC GARNITUUR	GATDEEL L/R
RVS 304	1240.2005.19	0652.5002.19	0652.5001.19	0511.2001.19	1240.2005.19LR

**TORRI** klasse 4 BIOV

					52mm rozet ROND- afmeting kruk <b>60x118mm</b>								
--	--	--	--	--	--	--	--	--	--	--	--	--	--

EN 1906 KLASSE 4

KLEUR/FINISH	KRUKSTEL	SLEUTELROZET	CILINDERROZET	WC GARNITUUR	GATDEEL L/R
RVS 316/304+ BIOV	1240.2005.59	0652.5002.59	0652.5001.59	0511.2001.59	1240.2005.59LR

## ROZETTEN ROND

### ROZETTEN ROND 52mm (per set)



KLEUR/FINISH	SLEUTELROZET	CILINDERROZET	BLIND ROZET
RVS 304	0652.5002.19	0652.5001.19	S926.0088
RVS 304 FLAT 2mm	2031.0311	2031.0321	
RVS 304 BIOV	0652.5002.59	0652.5001.59	
RVS 316 BIOV	0652.5002.48	0652.5001.48	S926.0048
RVS 316 BIOV FLAT 3m	0656.2001.46	0656.2002.46	
GOLD BIOV	0370.0020	0371.0020	0244.XX20
GOLD ANTIQUE BIOV	0370.00P2	0371.00P2	0244.xxP2
TECHNOSTEEL BIOV	0370.00N9	0371.00N9	0244.XXN9
BLACK PEARL BIOV	0370.00T3	0371.00T3	0244.XXT3
CRYSTAL BIOV	0370.0046	0371.0046	0244.XX46
WHITE PEARL BIOV	0370.0066	0371.0066	0244.XX66
NOIR BIOV	0370.0008	0371.0008	0244.XX08
CHROOM	0191.0007	0192.0007	
MAT CHROOM	0191.0012	0192.0012	

## TOILETGARNITUREN ROND

### TOILETGARNITUUR ROND



KLEUR/FINISH	
RVS 304	0511.2001.19
RVS 304 FLAT 2mm	2031.0331
RVS 304 BIOV	0511.2001.59
RVS 316 BIOV	0511.2001.48
RVS 316 BIOV FLAT 3m	0656.2003.46
GOLD BIOV	0678.3220
GOLD ANTIQUE BIOV	0678.32P2
TECHNOSTEEL BIOV	0678.32N9
BLACK PEARL BIOV	0678.32T3
CRYSTAL BIOV	0678.3246
WHITE PEARL BIOV	0678.3266
NOIR BIOV	0678.3208
CHROOM	0653.3207
MAT CHROOM	0653.3212

### TOILETGARNITUUR ROND ROOD-WIT



KLEUR/FINISH	
RVS 304 BIOV	0654.9015.19
RVS 316 BIOV	0654.9015.48
GOLD BIOV	0654.9015.01
TECHNOSTEEL BIOV	0654.9015.03
BLACK PEARL BIOV	0654.9015.04
CRYSTAL BIOV	0654.9015.07
WHITE PEARL BIOV	0654.9015.02
NOIR BIOV	0654.9015.08

## ROZETTEN VIERKANT

### ROZETTEN VIERKANT 52mm (per set)

		
KLEUR/FINISH	SLEUTELROZET	CILINDERROZET
RVS 304	0652.5004.19	0652.5003.19
RVS 304 FLAT 2mm	2030.03C1	2030.0321
RVS 316 BIOV	0652.5004.48	0652.5003.48
GOLD BIOV	0652.5004.01	0652.5003.01
TECHNOSTEEL BIOV	0652.5004.03	0652.5003.03
BLACK PEARL BIOV	0652.5004.04	0652.5003.04
CRYSTAL BIOV	0652.5004.07	0652.5003.07
NOIR BIOV	0652.5004.08	0652.5003.08
MAT CHROOM	0181.0012	0182.0012
CHROOM	0181.0007	0182.0007

## TOILETGARNITUREN VIERKANT

### TOILETGARNITUUR VIERKANT

		
KLEUR/FINISH		
RVS 304		0511.2002.19
RVS 304 FLAT 2mm		2030.0331
RVS 316 BIOV		0511.2002.48
GOLD BIOV		0511.2002.01
TECHNOSTEEL BIOV		0511.2002.03
BLACK PEARL BIOV		0511.2002.04
CRYSTAL BIOV		0511.2002.07
NOIR BIOV		0511.2002.08
CHROOM		0651.3207
MAT CHROOM		0651.3212

## LANGSCHILDEN



### LANGSCHILDEN OVAAL 40x235mm (per stuk)

KLEUR/FINISH	BLIND	SLEUTEL 56mm	CILINDER 55mm	CILINDER 72mm	TOILET 63/8mm	TOILETSTIFT
BLACK PEARL BIOV	0008.AAT3	0008.B1T3	0008.P8T3	0008.P3T3	0008.Y3T3	0715.32T3
CRYSTAL BIOV	0008.AA46	0008.B146	0008.P846	0008.P346	0008.Y346	0715.3246
GOLD BIOV	0008.AA20	0008.B120	0008.P820	0008.P320	0008.Y320	0715.3220
TECHNOSTEEL BIOV	0008.AAN9	0008.B1N9	0008.P8N9	0008.P3N9	0008.Y3N9	0715.32N9
WHITE PEARL BIOV	0008.AA66	0008.B166	0008.P866	0008.P366	0008.Y366	0715.3266
NOIR BIOV	0008.AA08	0008.B108	0008.P808	0008.P308	0008.Y308	0715.3208
CHROOM	0008.AA07	0008.B107	0008.P807	0008.P307	0008.Y307	0715.3207
MAT CHROOM	0008.AA12	0008.B112	0008.P812	0008.P312	0008.Y312	0715.3212





## RAAMBESLAG

### RAAMBOMEN DRAAI-KIEP CLAQ

 				
SAMENSTELLEN RAAMBOOM NIET AFSLUITBAAR: GATDEEL KRUK + DK MECHANISME + LOS KAPJE SAMENSTELLEN RAAMBOOM AFSLUITBAAR: GATDEEL KRUK + DK MECHANISME AFSLUITBAAR				
KLEUR/FINISH	DRAAI-KIEP MECHANISME NIET-AFSLUITBAAR M7x40mm	DRAAI-KIEP MECHANISME NIET-AFSLUITBAAR M7x50mm	LOS AFDEKKAPJE VOOR DRAAI-KIEP MECHANISME NIET-AFSLUITBAAR	DRAAI-KIEP MECHANISME AFSLUITBAAR M7x40mm
BLACK PEARL BIOV	0600.8019.26	0600.8021.26	0338.00T3	0605.4001.04
CRYSTAL BIOV	0600.8019.26	0600.8021.26	0338.0046	0605.4001.07
GOLD BIOV	0600.8019.26	0600.8021.26	0338.0020	0605.4001.01
TECHNOSTEEL BIOV	0600.8019.26	0600.8021.26	0338.00N9	0605.4001.03
WHITE PEARL BIOV	0600.8019.26	0600.8021.26	0338.0066	0605.4001.02
NOIR BIOV	0600.8019.26	0600.8021.26	0338.0008	0605.4001.08
RVS 304	0600.8019.26	0600.8021.26	0338.0088	0605.4001.19

### RAAMBOMEN DRAAI-KIEP

 				
SAMENSTELLEN RAAMBOOM NIET AFSLUITBAAR: GATDEEL KRUK + DK MECHANISME + LOS KAPJE SAMENSTELLEN RAAMBOOM AFSLUITBAAR: GATDEEL KRUK + DK MECHANISME AFSLUITBAAR				
KLEUR/FINISH	DRAAI-KIEP MECHANISME NIET-AFSLUITBAAR M7x40mm	DRAAI-KIEP MECHANISME NIET-AFSLUITBAAR M7x50mm	LOS AFDEKKAPJE VOOR DRAAI-KIEP MECHANISME NIET-AFSLUITBAAR	DRAAI-KIEP MECHANISME AFSLUITBAAR M7x40mm / 100x30x30
BLACK PEARL BIOV	1000.0000	1033.K700	0338.00T3	0611.70T3
CRYSTAL BIOV	1000.0000	1033.K700	0338.0046	0611.7046
GOLD BIOV	1000.0000	1033.K700	0338.0020	0611.7020
TECHNOSTEEL BIOV	1000.0000	1033.K700	0338.00N9	0611.70N9
WHITE PEARL BIOV	1000.0000	1033.K700	0338.0066	0611.7066
NOIR BIOV	1000.0000	1033.K700	0338.0008	0611.7008
RVS 304	1000.0000	1033.K700	0338.0088	1001.0088

## SCHUIFDEURKOM

		
PER SET - 125x39x10 (HxBxD)		
SCHUIFDEURKOM		
KLEUR/FINISH		
BLACK PEARL BIOV		0600.00T3
CRYSTAL BIOV		0600.0046
GOLD BIOV		0600.0020
TECHNOSTEEL BIOV		0600.00N9
WHITE PEARL BIOV		0600.0066
NOIR BIOV		0600.0008

## DEURKOM OPAL

		
PER STUK 120x50x12 (HxBxD)		
DEURKOM OVAAL RVS VERDEKT		
KLEUR/FINISH	PAGINA	
RVS 304	40	6224.0088

## DEURKOM SPECIAAL

		
PER STUK 160x85x38 (HxBxD)		
DEURKOM RECHTHOEK RVS		
KLEUR/FINISH	PAGINA	
RVS 304	41	S842.0088

## DEURKOM BOBY

		
PER STUK 100x51x10 (HxBxD)		
DEURKOM RVS ZICHTBARE MONTAGE		
KLEUR/FINISH		
RVS 304		6202.0088

## DEURKOM BRADLY

		
PER STUK 100x52x10 (HxBxD)		
DEURKOM RVS BLINDE MONTAGE		
KLEUR/FINISH	PAGINA	
RVS 304	40	6212.0088

## DEURKOM BRODY

		
PER STUK 155x45x17 (HxBxD)		
DEURKOM RECHTHOEK RVS VERDEKT		
KLEUR/FINISH	PAGINA	
RVS 304	40	6225.0088

## SCHARNIEREN

### KOGELLAGER SCHARNIER RVS



KLEUR/FINISH		
RVS 201 76x76mm		7691.6388
RVS 201 89x89mm		8991.2388
RVS 304 89x89mm		8990.2388

### KOGELLAGER VEILIGHEIDSSCHARNIER RVS



KLEUR/FINISH		
RVS 304 89x89mm		8995.2388

### KOGELLAGER SCHARNIER ZWART



KLEUR/FINISH		
ZWART 201 76x76mm		7691.6306
ZWART 201 89x89mm		8991.2306

## BUITENDEURBESLAG

### VOORDEURKNOPPEN VAST/DRAAIBAAR



KNOPPEN MET \* ZIJN DRAAIBAAR TOE TE PASSEN, BESTEL EEN VEERSLOT APART BIJ. \*\*CLIO IS DRAAIBAAR.

KLEUR/FINISH	DAPHNE*	VEERSLOT	CLIO L**	CLIO R**
GOLD BIOV	2482.3220	0020.FR01	8565.3220	8564.3220
GOLD ANTIQUE BIOV	2482.32P2	0020.FR01	8565.32P2	8564.32P2
TECHNOSTEEL BIOV	2482.32N9	0020.FR01	8565.32N9	8564.32N9
BLACK PEARL BIOV	2482.32T3	0020.FR01	8565.32T3	8564.32T3
CRYSTAL BIOV	2482.3246	0020.FR01	8565.3246	8564.3246
WHITE PEARL BIOV	2482.3266	0020.FR01	8565.3266	8564.3266
NOIR BIOV	2482.3208	0020.FR01	8565.3208	8564.3208

### VOORDEURKNOPPEN VAST



KNOP VAST

KLEUR/FINISH	SVEZIA
BLACK PEARL BIOV	2498.00T3
CRYSTAL BIOV	2498.0046
GOLD BIOV	2498.0020
GOLD ANTIQUE BIOV	2498.00P2
TECHNOSTEEL BIOV	2498.00N9
WHITE PEARL BIOV	2498.0066
NOIR BIOV	2498.0008

### VOORDEURKNOP RVS SYMMETRISCH



KNOP VAST - 55mm

KLEUR/FINISH	
RVS 304	S912.0088

### VOORDEURKNOP RVS EXCENTRISCH



KNOP VAST - 55mm

KLEUR/FINISH	
RVS 304	S913.0088

## VOORDEURGREPEN

DEURGREEP MODERN KLEIN	
	
DEURGREEP RVS 25x300mm h.o.h	
KLEUR/FINISH	
RVS 304	0571.1009.19

DEURGREEP TEKNO 45°	
	
DEURGREEP RVS 30x300mm h.o.h	
KLEUR/FINISH	
RVS 304	0571.1012.19

## DEURKLOPPERS



DEURKLOPPER ANELLO	
	
DEURKLOPPER BIOV 120mm	
KLEUR/FINISH	
BLACK PEARL BIOV	0688.00T3
CRYSTAL BIOV	0688.0046
GOLD BIOV	0688.0020
TECHNOSTEEL BIOV	0688.00N9
WHITE PEARL BIOV	0688.0066
ZWART RAL9005	0688.0008



DEURGREEP MODERN GROOT	
	
DEURGREEP RVS 25x400mm h.o.h	
KLEUR/FINISH	
RVS 304	0571.1010.19

DEURGREEP TEKNO	
	
DEURGREEP RVS 30x300mm h.o.h	
KLEUR/FINISH	
RVS 304	0571.1011.19



## VEILIGHEIDSRUZETTEN EN SCHILDEN

VEILIGHEIDSRUZETTEN BIOV						
						
VEILIGHEIDSRUZETTEN MET EN ZONDER UITTREKBEVEILIGING (UTB) SKG***						
KLEUR/FINISH	ROND - ZONDER UTB	BINNENKAPJE LOS (52mm)	ROND - MET UTB	BINNENKAPJE LOS (55mm)	VIERKANT - ZONDER UTB	VIERKANT - MET UTB
BLACK PEARL BIOV	0341.00T3	0229.Y0T3	0229.00T3	0229.U0T3	0632.3003.04	0632.3004.04
CRYSTAL BIOV	0341.0046	0229.Y046	0229.0046	0229.U046	0632.3003.07	0632.3004.07
GOLD BIOV	0341.0020	0229.Y020	0229.0020	0229.U020	0632.3003.01	0632.3004.01
GOLD ANTIQUE BIOV			0229.00P2			
TECHNOSTEEL BIOV	0341.00N9	0229.Y0N9	0229.00N9	0229.U0N9	0632.3003.03	0632.3004.03
WHITE PEARL BIOV	0341.0066	0229.Y066	0229.0066	0229.11003		
NOIR BIOV	0341.0008	0229.Y008	0229.0008	0229.U008	0632.3003.08	0632.3004.08
RVS 304	0341.0088	0229.Y088	0229.00IX	0229.U088	0632.3003.19	0632.3004.19



VEILIGHEIDSSSETS ACHTERDEUR RVS QUADRO						
						
VEILIGHEIDSSSET ACHTER: INC. KRUKSTEL						
ZONDER UTB			MET UTB			
KLEUR/FINISH	PC 55mm	PC 72mm	PC 92mm	PC 55mm	PC 72mm	PC 92mm
RVS 304	7873.1588	7873.1688	7873.3588	7878.1588	7878.1688	7878.3588

VEILIGHEIDSSSETS VOORDEUR RVS QUADRO						
						
VEILIGHEIDSSSET VOOR: INC. KNOP EN KRUK						
ZONDER UTB			MET UTB			
KLEUR/FINISH	PC 55mm	PC 72mm	PC 92mm	PC 55mm	PC 72mm	PC 92mm
RVS 304	7874.1588	7874.1688	7874.3588	7879.1588	7879.1688	7879.3588

## BELDRUKKERS

BELDRUKKERS			
			
	ROND	OVAAL	VIKANT
<b>KLEUR/FINISH</b>			
BLACK PEARL BIOV	6621.00T3	0601.00T3	
CRYSTAL BIOV	6621.0046	0601.0046	
GOLD BIOV	6621.0020	0601.0020	
GOLD ANTIQUE BIOV	6621.00P2		
TECHNOSTEEL BIOV	6621.00N9	0601.00N9	S911.00N9
WHITE PEARL BIOV	6621.0066	0601.0066	
NOIR BIOV	6621.0008	0601.0008	
RVS 304	S838.00IX	S809.00IX	S911.0088

## BRIEFPLATEN & TOCHTKLEPPEN

BRIEFPLATEN & TOCHTKLEPPEN					
Afmeting briefplaat 330 x 80 mm. Inwerpmaat 290 x 50 mm.					LETTERTYPE
GRAVEREN BRIEFPLAAT: STANDAARD ZWART, M.U.V. NOIR, CHOCO EN BLACK PEARL: WITTE LETTERS					
<b>KLEUR/FINISH</b>	<b>BRIEFPLAAT RECHTHOEK</b>	<b>BRIEFPLAAT OVAAL</b>	<b>TOCHTKLEP MET BORSTEL</b>	<b>GRAVEREN</b>	
BLACK PEARL BIOV	0650.00T3	0649.00T3	0692.9004.T3	0965	
CRYSTAL BIOV	0650.0046	0649.0046	0692.9004.46	0965	
GOLD BIOV	0650.0020	0649.0020	0692.9004.20	0965	
GOLD ANTIQUE BIOV	0650.00P2		0692.9004.P2	0965	
TECHNOSTEEL BIOV	0650.00N9	0649.00N9	0692.9004.N9	0965	
WHITE PEARL BIOV	0650.0066	0649.0066	0692.9004.66	0965	
NOIR BIOV	0650.0008	0649.0008	0692.9004.08	0965	
RVS 304	9650.0088	9649.0088	0692.9004.88		

### Letterttypen t.b.v. graveren briefplaat

GRAVEREN - standaard zwart, muv noir, choco en black pearl in wit

ARIAL - TYPE 1

GEORGIA - TYPE 2

### CLAQ KEY KLEIN



CLAQ KEY KLEIN

0681.5002.27

## DIVERSE KLEINE MATERIALEN

### CLEANINGSETS



RVS GLANS CLEAN

CL0002

BIOV & PVD SET

CL0001

### WISSELSTIFTEN CLAQ tbv SHOWROOMBORDEN

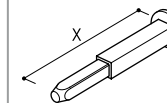

CLAQ KRUKSTIFT VOOR GATDEEL - DOOR-EN-DOOR MONTAGE

65mm

0672.7256.26

85mm

0672.7260.26

100mm

0672.7263.26

## WISSELSTIFTEN

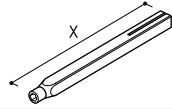
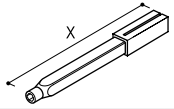

VOOR GATDEEL

CLAQ		NIET CLAQ		NIET CLAQ	
7x55mm ZN CLAQ	0672.7132.26	7x55mm ZN	0055.E7ZN	8x55mm ZN	0055.E8ZN
7x65mm ZN CLAQ	0672.7133.26	7x65mm ZN	0065.E7ZN	8x65mm ZN	0065.E8ZN
7x85mm ZN CLAQ	0672.7134.26	7x85mm ZN	0085.E7ZN	8x85mm ZN	0085.E8ZN

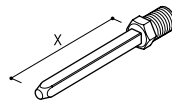
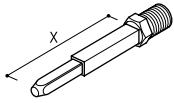

VOOR VOORDEUR TBV VEILIGHEIDSGARNITUUR

CLAQ		NIET CLAQ		NIET CLAQ	
7x70mm	0672.7125.26	7x70mm	0070.H7ZN	8x70mm	0070.H8ZN
7x90mm	0072.7126.26	7x90mm	0090.H7ZN	8x90mm	0090.W8ZN

## KRUKSTIFTEN

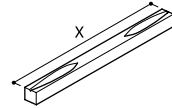
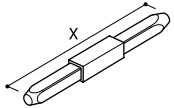

CLAQ		NIET CLAQ		NIET CLAQ	
7x115mm	0672706626	7x100mm	0100.H7ZN	8x100mm	0100.H8ZN
7x135mm	0672706826	7x120mm	0120.H7ZN	8x120mm	0120.H8ZN
7x155mm	0672707026	7x140mm	0140.H7ZN	8x140mm	0140.H8ZN

**Almar Südmetall Group**

Rucphensebaan 52, 4706 PJ Roosendaal | Tel: 0165-565903 | [asgbenelux.nl](http://asgbenelux.nl)